



**TECHNICAL STANDARDS AND GUIDELINES
for Builders and Engineers**

*for Areas Designated as Active Soils in the State of Texas
and for Areas Designated Catastrophe Areas by the Texas Department of Insurance*

CONTENTS

Introduction	2
Part I: Underwriting Requirements	3
Part II: Foundation.....	3
Part III: Framing Inspection	4
Part IV: Final Inspection.....	5
Part V: Final Grading Certification	5
Part VI: Engineer and Land Surveyor Questionnaire	6
Part VII: Independent Fee Inspector Questionnaire	6
Appendix A.....	7
Appendix A-1	8
Appendix A-2.....	9
Appendix B.....	10
Attachment A: Areas Designated as Active Soils	11
Attachment B: Sample Engineer and Land Surveyor Questionnaire	12
Attachment C: Sample Independent Fee Inspector Questionnaire	14
Attachment D: Home Enrollment Flow Chart	16
Modular Addendum	17
Areas Designated Catastrophe Areas Standards and Guidelines Addendum	17

INTRODUCTION New Home Construction Criteria

This book sets forth the special requirements which MUST be followed for a home to be eligible for enrollment into the HOME of Texas Limited Warranty Program. The Technical Standards and Guidelines for Builders and Engineers (TSGBE) is in addition to the requirements set forth in the Builder Agreement between a member Builder and HOME of Texas (HOME).

The main emphasis is on foundation systems. The TSGBE specifies the minimum requirements for conventional steel-reinforced concrete slab-on-grade foundations. If you choose to have another type of foundation, you must have a professional engineer design the foundation system.

The TSGBE also establishes specific criteria for final grade certifications with final grade elevations and qualifications for engineers and fee inspectors.

For those counties currently designated as Active Soil Areas (see Attachment A), the requirements set forth in this book become effective on homes initially enrolled in those areas on or after January 1, 1997. For homes enrolled in any county not listed as an Active Soil Area, the foundation system is required to be engineered in accordance with the Membership Agreement.

OVERVIEW OF THE TSGBE:

1. All foundations in Texas are required to be engineered. See Part II for information on an alternate foundation system also accepted by HOME of Texas. See Modular Addendum for modular homes that fall within the Texas Department of Licensing and Regulation for Industrialized Housing and Buildings.
2. Grade elevations are required to be submitted with Final Grade Certifications. Please see Part V of the Standards for compliance options and details.

The Final Grade Certification performed by an independent fee inspector must be accompanied by grade elevations to verify positive drainage around the perimeter of the home. This type of Final Grade Certification must be performed by an independent fee inspector on forms made available by HOME (#8216). See Part V.A and V.B for more information.

More detailed information on requirements pertaining to final grade surveys is contained in Part V.B. There are specific statements which must appear on this document. If you have utilized this method in the past, please be sure to provide this new information to your surveyor.

3. Engineers and land surveyors must meet certain qualifications. A questionnaire (#8136) provided upon request by HOME, must be completed and approved by HOME. See Part VI for additional information regarding criteria.
4. A HOME of Texas Approved Engineers and Inspectors Report is available. Use of an Inspector or Engineer on this list does not excuse Member from any Membership obligations. HOME of Texas and Western Pacific Mutual Insurance Company, A Risk Retention Group (WPMIC), are not and shall not be responsible for any error or omission of the Inspectors and Engineers on the list.

If you have any questions, please contact your HOME Account Executive or the Inspections Department at 1-800-445-8173.

PART I Underwriting Requirements

- A. The foundation of the home must:
 - 1. meet or exceed the minimum foundation criteria set forth in Part II of this publication; or
 - 2. be designed by a professional engineer who has met the qualification standards established by HOME (see Part VI). The design of the foundation plan must bear the design engineer's seal and signature.
 - 3. If the home is a modular home and falls within the Texas Department of Licensing and Regulation for Industrialized Housing and Buildings, the Modular Addendum will apply.
- B. The framing system must be inspected prior to the installation of sheetrock, but after the installation of all plumbing, electrical, heating, ventilating and mechanical systems (Framing Inspection). This inspection must be performed by:
 - 1. an independent fee inspector who has met the qualification standards as established by HOME (see Part VII); or
 - 2. a recognized municipal agency (please refer to your membership letter of approval).
 - 3. See Part III.
- C. A Final Inspection may be required upon the completion of the home, prior to occupancy. This inspection must be performed by:
 - 1. an independent fee inspector who has been approved by HOME (see Part VII).
- D. Final Grade Certification and Final Grade Elevation Surveys must be submitted. The purpose of these documents is to verify that adequate and proper grading and drainage has been established by the Builder at the time of construction.
 - 1. See Part V.

PART II Foundation

Every home which a member Builder elects to construct and enroll into the HOME Limited Warranty Program must meet or exceed the standards and guidelines set forth below.

Where the foundation will be of conventional steel reinforced concrete slab-on-grade construction, the Builder may utilize the minimum specifications set forth in Appendix A.

For other types of foundations, including, but not limited to, post-tension slabs, pier and beam foundations, etc., the foundation system must be designed by a professional engineer who has met the qualification standards established by HOME (see Part VI). In addition, the most current revision at the time of the foundation's construction of the Recommended Practice for the Design of Residential Foundations, by the Texas Section, American Society of Civil Engineers, Section 4. Geotechnical Investigation shall be followed.

- A. Minimum Foundation Specifications: The following general notes represent the minimum foundation requirements for foundations of homes constructed for enrollment into the HOME Limited Warranty Program. Where local governing or regulatory agencies have other requirements, the more stringent requirement shall apply. For instance, if a home is being constructed in a city where specific engineering is required, that requirement shall take precedence over the minimum specifications established herein. Where a Builder chooses to construct a foundation other than in accordance with the Minimum Foundation Specifications, or where a city may require engineering, the foundation plan must be designed by a professional engineer, who has met the qualification standards set forth in Part VI.

Where a Builder has knowledge, such as through a soils investigation report, that a more stringent foundation design should be implemented, the Builder must comply with the more stringent requirements.

- B. General Notes: The following General Notes shall apply to the minimum foundation specifications:
 - 1. The elevation of the top of the slab shall be a minimum of twelve (12) inches above the highest natural grade elevation at the perimeter of the slab.
 - 2. The grade beams and slab area shall be free of topsoil, uncontrolled existing man-made fill and soil containing organic matter.
 - 3. The grade beams and slab area shall be free of standing water when concrete is placed.
 - 4. All beams must extend a minimum of six (6) inches into undisturbed soil or controlled fill material which has been placed in accordance with accepted standards, such as the Standard Proctor Density according to ASTM 698 or HUD data sheet 79-g, or its replacement.
 - 5. All forms shall be well-braced and straight.

6. A six (6) mil polyethylene vapor barrier shall be placed under all slabs. All laps shall be taped.
7. Concrete slabs, with a minimum thickness of four (4) inches, shall be reinforced with 6x6-6 ga wire mesh, placed two (2) inches below the top of the concrete; or 3/8 inch steel rods, spaced a maximum of sixteen (16) inches on center and tied.
8. Reinforcing bars shall be supported, beginning at a distance of twelve (12) inches from beam intersections and corners, at a maximum of forty-eight (48) inches on center, using #2 stirrups.
9. All #3 bars shall be 40 grade steel. All #4 or larger bars shall be ASTM A-615 grade 60.
10. Exterior beams supporting masonry walls shall be tied to the slab with #4 dowel bars, spaced thirty-six (36) inches on center, extending thirty-two (32) inches into the slab, and sixteen (16) inches into the beam, bent down at a thirty (30) degree angle. Corners are to be reinforced with #4 bars.
11. For pre-fab fireplaces with masonry surrounds, the slab shall be thickened to a minimum of six (6) inches, with #5 bars placed twelve (12) inches on center in both directions. These bars must project a minimum of sixteen (16) inches into the floor slab. For prefab fireplaces with wood surrounds, normal slab construction may be utilized.
12. For masonry fireplaces, the slab shall be thickened to the depth of the interior and perimeter beams, with a minimum penetration of six (6) inches into undisturbed soil. Reinforcements shall be #4 bars, top and bottom, spaced six (6) inches on center in both directions. The bars must project a minimum of sixteen (16) inches into the floor slab.
13. Concrete shall conform to the latest edition of ACI 318.
14. Where field splices of the reinforcing occurs, bars shall be lapped a minimum distance of thirty (30) times the diameter of the bar.
15. Water shall not be added to the concrete at the job site. If more workability is needed, the contractor shall specify the required slump on the job order.
16. Concrete shall not be placed at temperatures below forty (40) degrees Fahrenheit, in rainy weather, or during other adverse conditions.
17. Concrete shall not be placed in excess of five-and-one-half (5½) inch slump.
18. Concrete shall be properly consolidated.
19. Concrete shall reach a minimum strength of 2500 psi at twenty-eight (28) days

C. Engineered Foundation: Where the Builder chooses to use a foundation other than as set forth above, the design must be prepared by a professional engineer, currently registered in the state of Texas and who has met the qualification standards of HOME (see Part VI).

To design the foundation, the professional engineer must be knowledgeable and familiar with the soil con-

ditions and characteristics of the area where the home will be located. The design engineer shall determine the necessity, location(s) and extent of geotechnical soil investigations for the purpose of designing the foundation system.

The following recommendations are provided to the design engineer for his/her use in designing the foundation system:

1. All beams should extend a minimum of six (6) inches into undisturbed soil or controlled fill material which has been placed in accordance with accepted standards, such as the Standard Proctor Density according to ASTM 698 or HUD data sheet 79-g, or its replacement.
2. The elevation of the slab should not be less than twelve (12) inches above the highest natural grade elevation at the perimeter of the foundation.
3. Specific items which should be included on the plan, include, but are not limited to:
 - a. lot, block, and subdivision
 - b. engineer's seal and signature
 - c. concrete strength at twenty-eight (28) days
 - d. concrete strength at time of stressing
 - e. fill certification requirements
 - f. tendon spacing
 - g. typical details to cover site conditions, including trees and underground utility trenches.

PART III Framing Inspection (Allows for Municipal Inspection)

Every home enrolled into the HOME Limited Warranty Program must receive a Framing Inspection. This inspection is performed prior to the application of interior wall coverings such as sheetrock. However, all framing should be complete, as well as the installation of the electrical, plumbing, mechanical and ventilating systems.

In some cases, the Builder is required to have an approved HOME independent fee inspector perform the Framing Inspection. The Builder should be certain to review the approval letter submitted to them upon acceptance into the program. The approval letter outlines the inspections required for each home enrolled in the program. It is possible that a Framing Inspection will be required for homes in addition to the Foundation Requirements. Failure to provide the required inspections may delay the release of your warranty documents.

PART IV Final Inspection

A Final Inspection may be required upon the completion of the home, prior to occupancy.

In some cases, the Builder is required to have an approved HOME independent fee inspector perform a Final Inspection. The Builder should be certain to review the approval letter submitted to them upon acceptance into the program. The approval letter outlines the inspections required for each home enrolled into the program. If you are required to obtain a Final Inspection from an approved HOME independent fee inspector, the home should be completed and ready for occupancy.

A copy of this evaluation should be submitted to HOME along with the warranty document after closing. Validation of the warranty document may depend on the result of the Final Inspection.

The Final Inspection which is intended to address workmanship concerns should not be confused with the Final Grade Certification with Final Grade Elevations. (See Part V)

PART V Final Grading Certification

Lot grading and drainage, including porches and driveways, shall be provided so as to drain surface water away from the foundation. Where no final grade plan exists, positive drainage shall be provided so that water flows away from the foundation. Where gutters and downspouts or other roof drainage are provided by the Builder, discharge shall be provided to direct the water away from the foundation.

Every home enrolled into the HOME Limited Warranty Program must receive a final grading certification. There are two types of final grade certifications acceptable to HOME. The Builder must choose one (A or B) of the following:

- A. Final Grade Certification With Final Grade Elevations.
 - 1. A final grade certification is completed by an independent fee inspector who has met the qualifications of HOME. The independent fee inspector is required to take photographs which reveal all sides of the structure and adequately shows the finished grade in its final state. These photos must be submitted with the Final Grade Certificate. This certification must be on forms available from HOME (#8216). The purpose of the Final Grade Certification is to verify the establishment of positive drainage. A copy of the Final Grade Certification MUST be provided to homeowner at closing.
 - 2. To establish original Final Grade Elevations, the elevation survey shall include specific elevation points with dimensions and directional drainage flow arrows to verify positive drainage has been established within the first 10-feet around the perimeter of the foundation and that the lots are

graded to drain surface water away from the home. Lots shall be graded to drain surface water away from the foundation. The grade shall fall a minimum of 6-inches within the first 10-feet. Where lot lines, walls, slopes or other physical barriers prohibit 6-inch within 10-feet, the finish grade shall slope a minimum of 5% and directed to drains or swales to ensure drainage away from the structure. Swales shall be sloped a minimum of 2% when located within 10-feet of the building. Impervious surfaces within 10-feet shall be sloped a minimum of 2% away from the building.

Therefore, all Builder Members enrolling homes through HOME of Texas are required to complete the required elevation survey and keep it on file for a minimum of ten years after enrollment of a home. The Builder Member will also provide a copy of these elevations to HOME of Texas along with the Application for Enrollment prior to validation of the home's warranty.

- B. Final Grading Survey — This survey must be completed by a professional land surveyor or professional engineer who has met the qualifications of HOME. The survey must contain the following:
 - 1. A legal description of the property including lot, block, sub-division, street address, city, state, zip code and county.
 - 2. The name of the surveyor or engineer performing the survey.
 - 3. Photographs which reveal all sides of the structure and adequately show the grading in its final state.
 - 4. To establish original Final Grade Elevations, the elevation survey shall include specific elevation points with dimensions and directional drainage flow arrows to verify positive drainage has been established within the first 10-feet around the perimeter of the foundation and that the lots are graded to drain surface water away from the home. Lots shall be graded to drain surface water away from the foundation. The grade shall fall a minimum of 6-inches within the first 10-feet. Where lot lines, walls, slopes or other physical barriers prohibit 6-inch within 10-feet, the finish grade shall slope a minimum of 5% and directed to drains or swales to ensure drainage away from the structure. Swales shall be sloped a minimum of 2% when located within 10-feet of the building. Impervious surfaces within 10-feet shall be sloped a minimum of 2% away from the building.

Therefore, all Builders Members enrolling homes through HOME of Texas are required to complete the required elevation surveys and keep them on file for a minimum of ten years after enrollment of a home. The Builder Member will also provide a copy of these elevations to HOME of Texas along with the Application for Enrollment prior to validation of the home's warranty.

5. When a professional land surveyor or professional engineer are providing elevation surveys and grading information for enrolling a home the information from Page 1 of the HOME of Texas Final Grade Certification form (#8216) is still required. HOME requires that in addition to the drawings the builder provide the completed Page 1 of the Final Grade Certification form either from the land surveyor, professional engineer or a HOME approved fee inspector. HOME will also accept the information from Page 1 of the Final Grade Certification form on a signed and sealed letter from the land surveyor or professional engineer.
6. Lot elevations within the first 10-feet around the perimeter of the foundation at all corners of the structure and at the corners of the lot.
7. Location and directional indicators of drainage swales surrounding the structure.
8. A declaration or certification (or similar language approved by HOME of Texas) stating:
"I hereby declare that the elevations and drainage patterns shown hereon were developed from a survey of this property, performed on _____, 20____, and accurately and truly depict the elevations as they existed on this date. The relative elevations as depicted, may change subsequent to the date of this survey due to consolidation or upheaval of the soil; addition or removal of the soil by acts of man; erosion by wind or water; or other factors. Therefore, this survey may not depict the elevations and drainage patterns of this property after the date of this survey."
"The elevations and drainage patterns shown above are the certified findings of the professional engineer or land surveyor of the finished ground grades around the structure on the date of the survey. The homeowner must maintain these elevations and grades to properly drain the water away from the home."
9. The seal and signature of the land surveyor or professional engineer. A copy of this Final Grade Certification with Final Grade Elevations MUST be provided to homeowner at closing.

See Appendix B as a guide.

PART VI Engineer and Land Surveyor Questionnaire

HOME will accept foundation designs and other related services only from engineers and surveyors who have met certain qualification standards. To be eligible to perform required services for member Builders, the professional engineer or land surveyor must complete the appropriate questionnaire (#8136) and return it to HOME for review and authorization to perform such services.

Temporary authorization may be granted pending the completion of the review process. Engineers or surveyors who do not meet the preferred qualifications set forth below may submit a questionnaire, with supporting documentation regarding other qualifications, for review.

Standard qualifications:

1. A professional engineer or land surveyor who holds a current registration in the state of Texas.
2. A proven record of knowledge and experience with the soil conditions and characteristics associated with construction in Texas.
3. A proven record of experience and qualifications in designing residential foundation systems in the state of Texas.

PART VII Independent Fee Inspector Questionnaire

All independent fee inspectors who desire to be authorized to perform Construction Evaluations (also known as Framing Inspections and Final Inspections) and Final Grade Certifications for Builders who are members of the HOME Limited Warranty Program, must complete the appropriate questionnaire (#8137). Independent fee inspectors who do not meet the preferred qualifications set forth below may submit a questionnaire, with supporting documentation regarding other qualifications, for review.

Standard qualifications:

1. A professional building inspector, who has successfully obtained certification from a recognized organization, such as, but not limited to: IRC, IBC, SBCCI, ICBO, BOCA, or CABO.
2. A proven record of knowledge and experience with foundations, soil conditions and characteristics with respect to residential construction in Texas.
3. A proven record of inspecting foundation systems and/or framing systems during construction of residential structures in Texas.

TYPICAL FLOOR PLAN

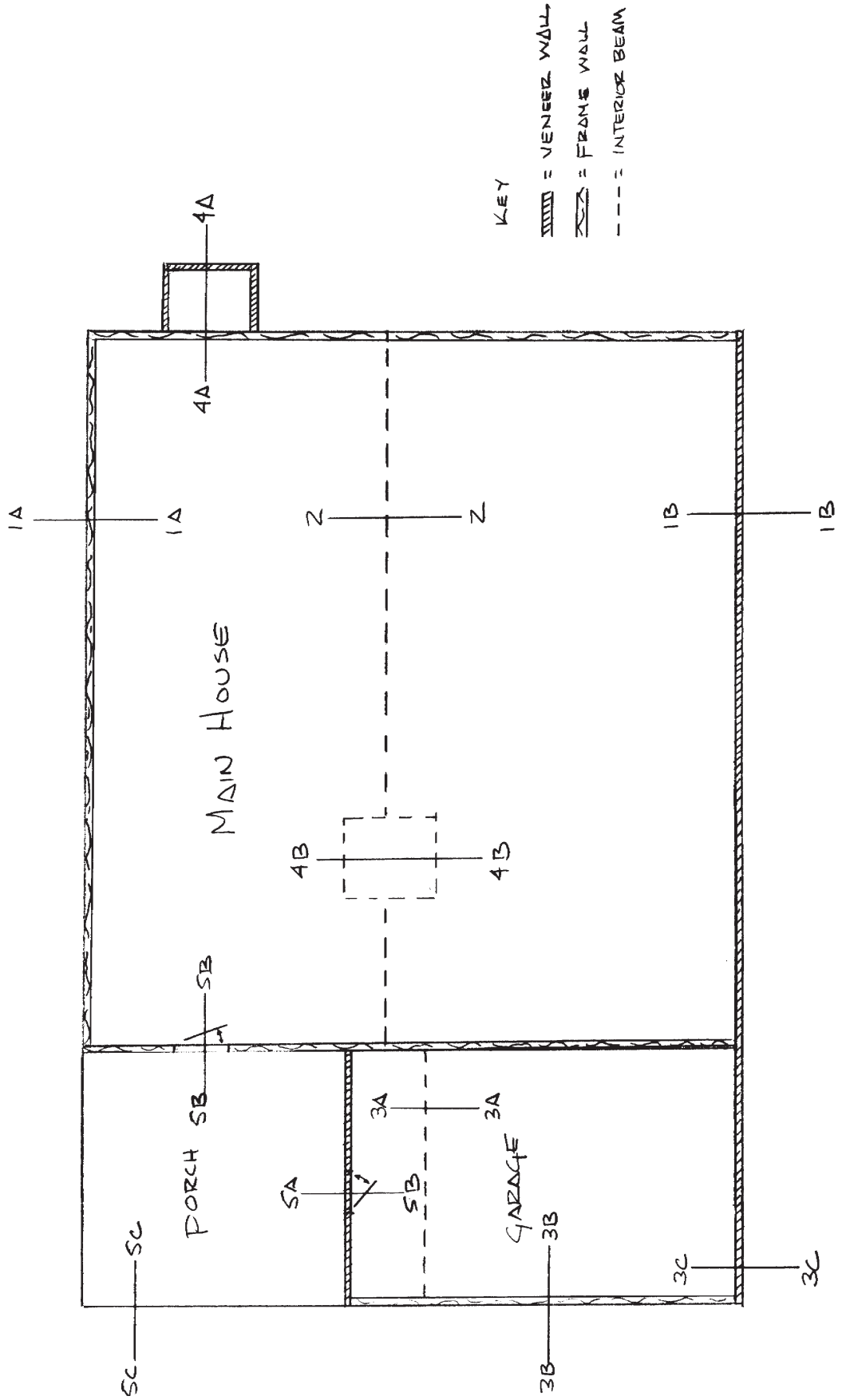

DETAIL 1 A

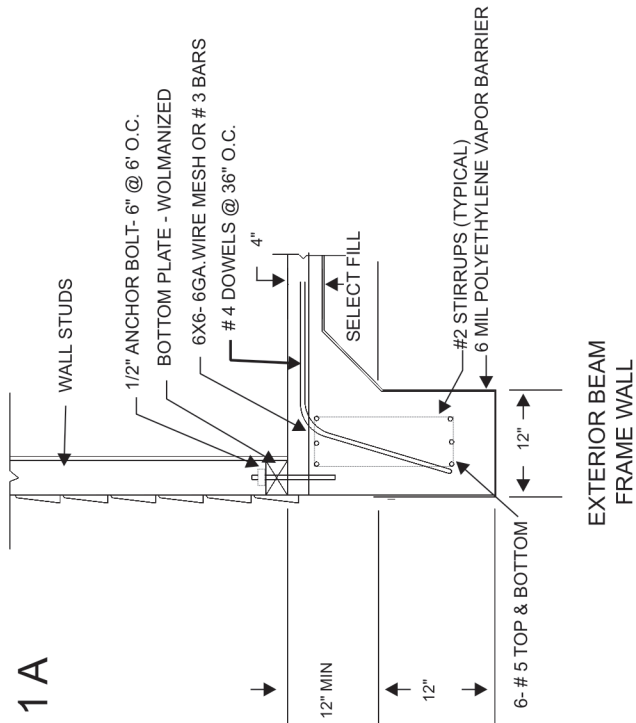

DETAIL 1 B

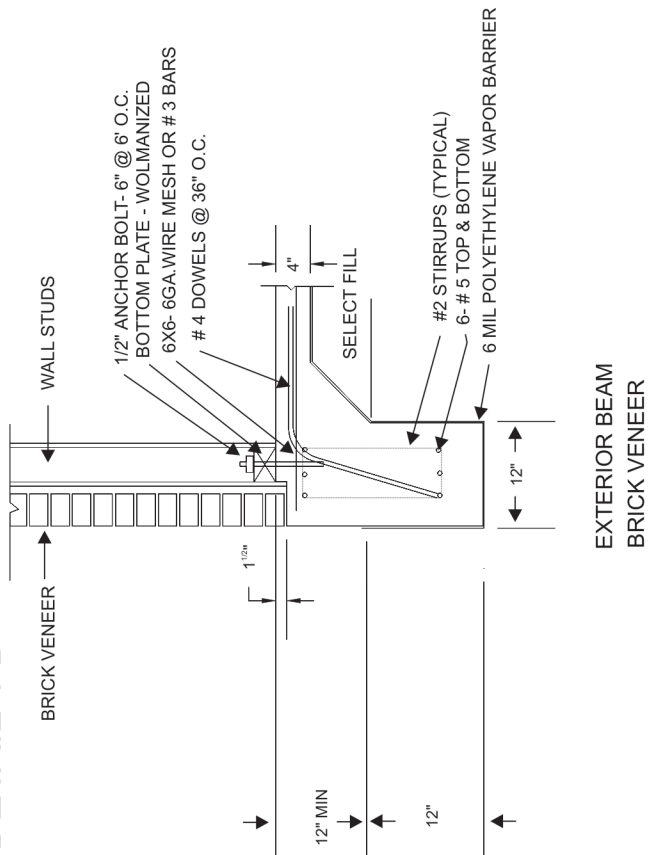

DETAIL 2

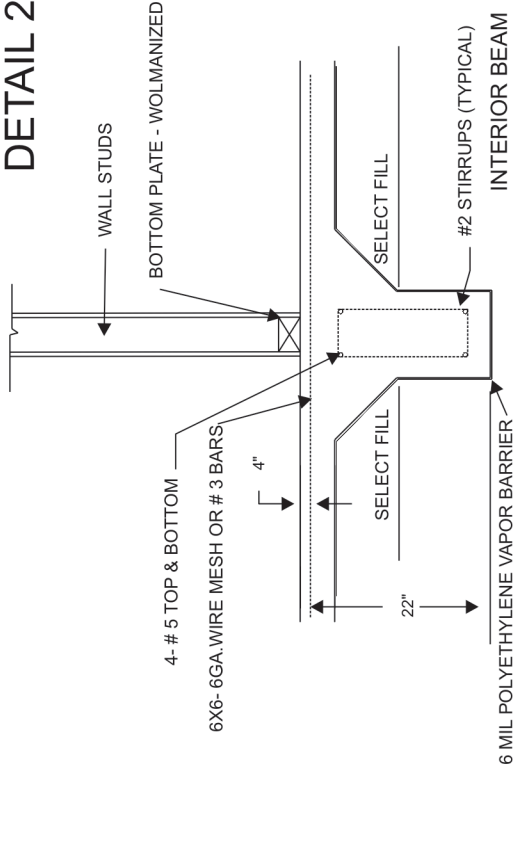

DETAIL 3 A

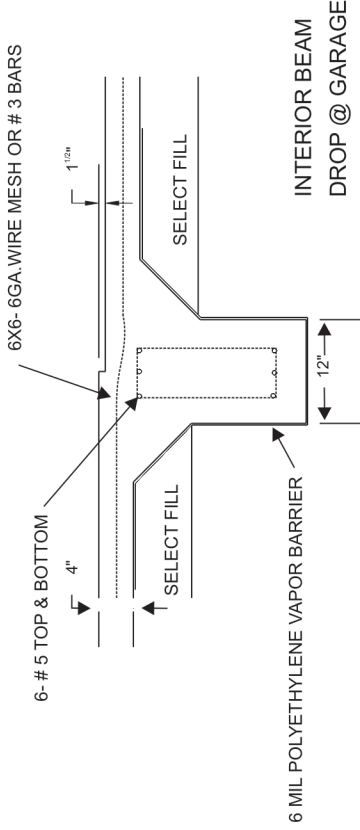

DETAIL 3 B

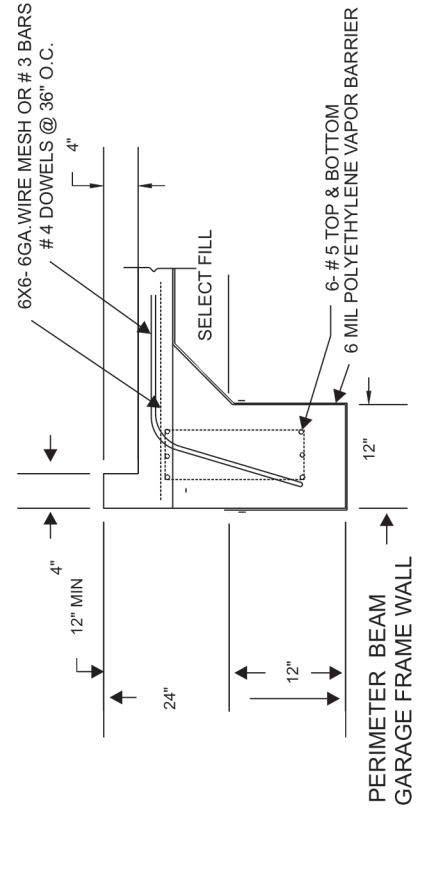

DETAIL 5 A

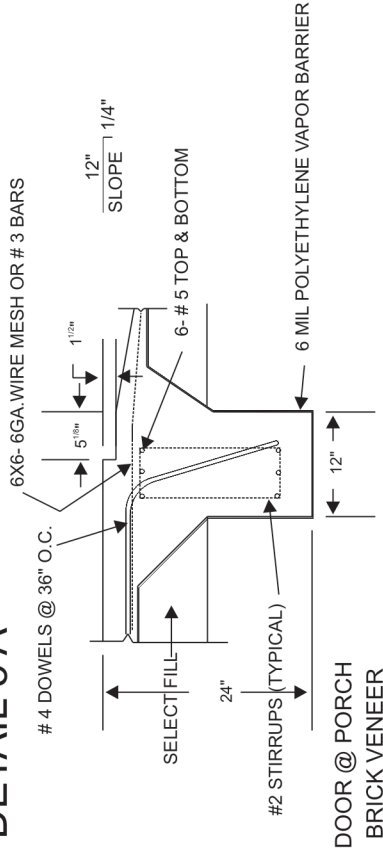

DETAIL 5 B

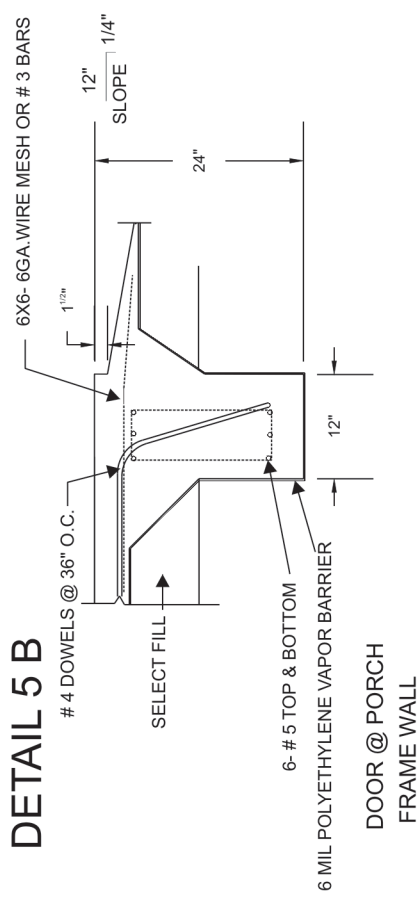

DETAIL 5 C

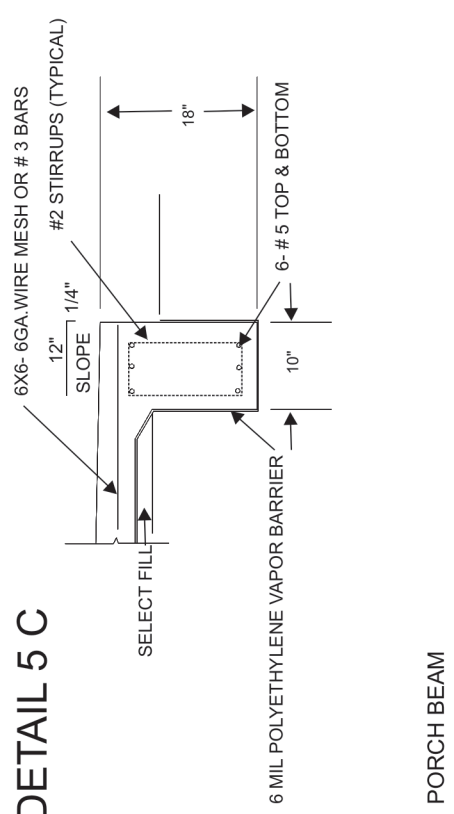

DETAIL 3 C

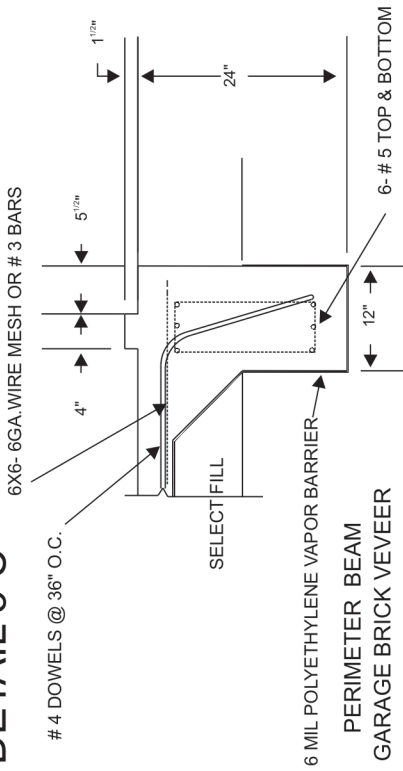

DETAIL 4 A

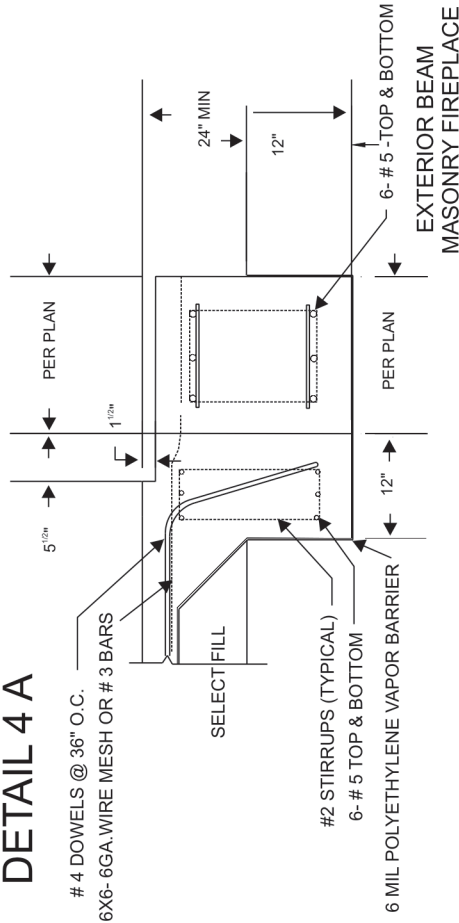

DETAIL 4 B

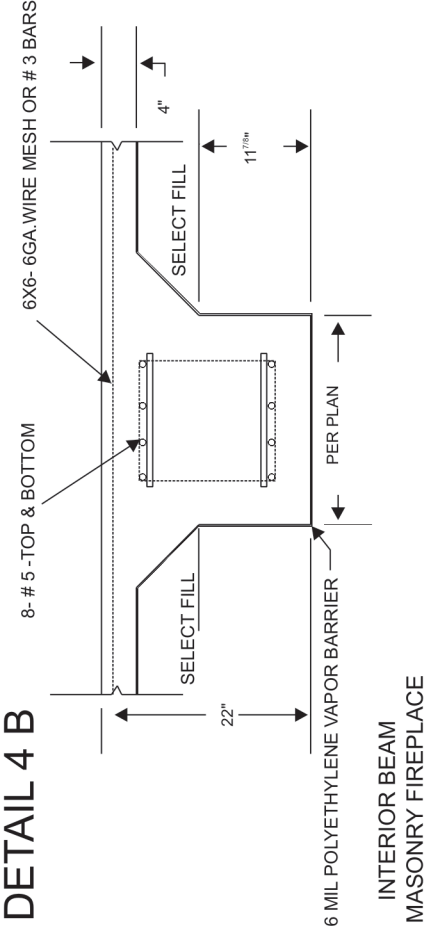



AREAS DESIGNATED AS ACTIVE SOILS

January 1, 1994

The following counties have been designated as having active soils. This may include, but not necessarily be limited to, expansive, compressive, collapsible, filled or other problem soils.

TEXAS COUNTIES DESIGNATED AS ACTIVE SOIL AREAS:

ANDERSON	CORYELL	HIDALGO	MATAGORDA	SHELBY
ANGELINA	DALLAS	HILL	MAVERICK	SMITH
ATASCOSA	DELTA	HOOD	MCCULLOCH	SOMERVELL
AUSTIN	DENTON	HOPKINS	MCLENNAN	STARR
BANDERA	DEWITT	HOUSTON	MCMULLEN	STEPHENS
BASTROP	DIMITT	HUNT	MEDINA	TARRANT
BAYLOR	DUVAL	JACK	MENARD	TAYLOR
BEE	EASTLAND	JACKSON	MILAM	THROCKMORTON
BELL	EDWARDS	JASPER	MILLS	TITUS
BEXAR	ELLIS	JEFFERSON	MONTAGUE	TRAVIS
BLANCO	ERATH	JIM HOGG	MONTGOMERY	TRINITY
BOSQUE	FALLS	JIM WELLS	MORRIS	TYLER
BOWIE	FANNIN	JOHNSON	NACOGDOCHES	UPSHUR
BRAZORIA	FAYETTE	JONES	NAVARRO	UVALDE
BRAZOS	FOARD	KARNES	NEWTON	VANZANDT
BROOKS	FORT BEND	KAUFMAN	NUECES	VICTORIA
BROWN	FRANKLIN	KENDALL	ORANGE	WALKER
BURLESON	FREESTONE	KENNEDY	PALO PINTO	WALLER
BURNET	FRIO	KERR	PANOLO	WASHINGTON
CALLAHAN	GALVESTON	KIMBLE	PARKER	WEBB
CALDWELL	GILLESPIE	KINNEY	POLK	WHARTON
CALHOUN	GOLIAD	KNOX	RAINS	WICHITA
CAMERON	GONZALES	LAMAR	REAL	WILBARGER
CAMP	GRAYSON	LAMPASSAS	RED RIVER	WILLACY
CASS	GREGG	LASALLE	REFUGIO	WILLIAMSON
CHAMBERS	GRIMES	LAVACA	ROBERTSON	WILSON
CHEROKEE	GUADALUPE	LEE	ROCK WALL	WISE
CLAY	HAMILTON	LEON	RUNNELS	WOOD
COLEMAN	HARDEMAN	LIBERTY	RUSK	YOUNG
COLLIN	HARDIN	LIMESTONE	SABINE	ZAPATA
COLORADO	HARRIS	LIVE OAK	SAN AUGUSTINE	ZAVALA
COMAL	HARRISON	LLANO	SAN JACINTO	
COMANCHE	HASKELL	MADISON	SAN PATRICIO	
CONCHO	HAYS	MARION	SAN SABA	
COOKE	HENDERSON	MASON	SHACKLEFORD	



5300 Derry Street, Harrisburg, PA 17111

PHONE: 717-561-4480

FAX: 717-561-4494

Independent Fee Inspector Questionnaire

The following questionnaire must be completed in its entirety to be considered for acceptance by HOME of Texas (HOME). This acceptance entitles the engineering or surveying firm to perform functions in accordance with the HOME Technical Standards and Guidelines utilized by the Limited Warranty Program.

Name of Individual/Company _____

Address _____
street city state zip

Telephone _____ Email _____

Name and Title of Person Completing this Questionnaire _____

Engineers, Architects and/or Surveyors affiliated with this company:

NAME	CERTIFICATION	YEAR OBTAINED	FIELD OF EMPHASIS

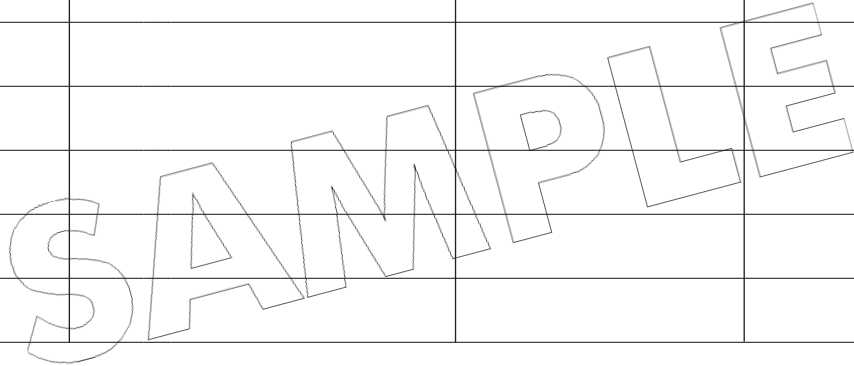

Technicians or Authorized Representatives affiliated with the company that may be performing services:

NAME	LEVEL OF TRAINING

Have any of the persons above ever had his/her registration or license suspended or revoked in any state? Yes No
 If yes, explain. _____

(If additional space is needed, use another sheet of paper.)

CERTIFICATIONS AND/OR LICENSES - PLEASE INCLUDE A PHOTOCOPY OF ALL APPLICABLE CERTIFICATIONS AND LICENSES, FOR EACH STATE THAT YOU ARE AFFILIATED.

Services Available:

ATTACHMENT B

TYPE	YES	NO	YEARS OF EXPERIENCE	FOR OFFICIAL USE ONLY (Y/N Initials)
Geotechnical Investigations				
Foundation Design				
Framing Design				
Framing Inspection				
Final Grading Surveys				
Other (Specify)				

1. Would you like to perform Fact-Finding Inspections on an as-needed basis? ___ Yes ___ No

2. Do technicians work under the direct supervision and control of a professional engineer or surveyor affiliated with this company? ___ Yes ___ No

3. What are the minimum qualifications for all technicians utilized by this firm? _____

4. Are laboratories and operations available to HOME personnel for observations? ___ Yes ___ No

5. Does this company maintain liability insurance coverage? ___ Yes ___ No *If yes, please attach a copy of Liability Insurance coverage.*

6. List all lawsuits this company or affiliated personnel have been involved in during the past three years. _____

7. Provide three recommendations from colleagues or other construction industry professionals.

NAME	ADDRESS	OCCUPATION	PHONE

I hereby declare that the information provided in this questionnaire is true and accurate to the best of my knowledge and ability. I hereby authorize HOME permission to verify any or all information provided herein. I understand that any false information provided on this questionnaire may be considered as sufficient cause for rejection of this form, or for removal from the authorized list of engineers and surveyors if such false statement is discovered after my approval.

Applicant's Signature

Date

FOR OFFICIAL USE:

Approved _____ Rejected _____ By _____
Date Date HOME of Texas Representative



5300 Derry Street, Harrisburg, PA 17111

PHONE: 717-561-4480

FAX: 717-561-4494

Independent Fee Inspector Questionnaire

Name of Individual/Company _____

Address _____
street city state zip

Telephone _____ Email _____

Name and Title of Person Completing this Questionnaire _____

Inspectors affiliated with this company:

NAME	CERTIFICATION	YEAR OBTAINED	FIELD OF EMPHASIS

Have any of the inspectors listed above ever had their license or certification suspended or revoked? Yes No
 If yes, explain _____

Please provide the following information for each inspector affiliated with your company:

Services Available:

TYPE	YES	NO	YEARS OF EXPERIENCE
Footing/Foundation			
Framing before Drywall			
Final/Completed			
Final Grading Surveys			
Other (Specify)			

ATTACHMENT C

Education (Check appropriate items)

___ High School ___ Some College ___ Degree Other (Specify) _____

Technical Training _____

CERTIFICATIONS AND/OR LICENSES - PLEASE INCLUDE A PHOTOCOPY OF ALL APPLICABLE CERTIFICATIONS AND LICENSES, FOR EACH STATE THAT YOU ARE AFFILIATED.

Previous Work History — Please attach a copy of your current resume detailing **CONSTRUCTION RELATED EXPERIENCE**.

References - List only individuals familiar with your inspection skills and work experience. (Not relatives)

NAME	ADDRESS	OCCUPATION	PHONE

I hereby declare that the information provided in this questionnaire is true and accurate to the best of my knowledge and ability. I hereby authorize HOME of Texas (HOME) permission to verify any or all information provided herein. I understand that any false information provided on this questionnaire may be considered as sufficient cause for rejection of this form, or for removal from the authorized list of independent fee inspectors if such false statement is discovered after my approval.

Applicant's Signature _____

Date _____

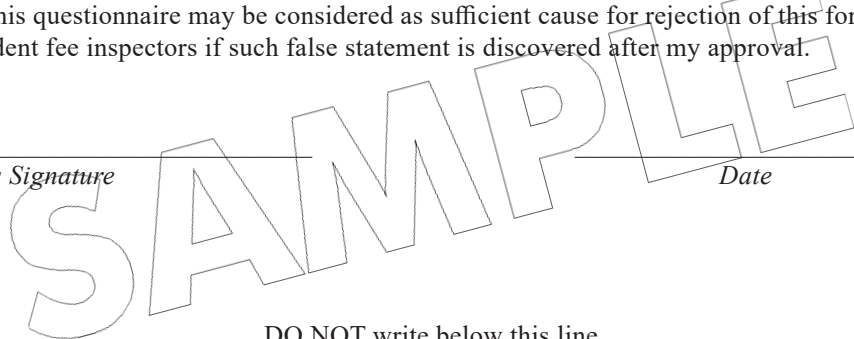

DO NOT write below this line

FOR OFFICE USE ONLY

Approved _____
Date

Rejected _____ By _____
Date HOME Representative

ITEM #	DESCRIPTION	YES	NO	INITIALS
1.	Footing/Foundation			
2.	Framing before Drywall			
3.	Final/Completed			
4.	Final Grade Certifications			

Home Enrollment Flow Chart

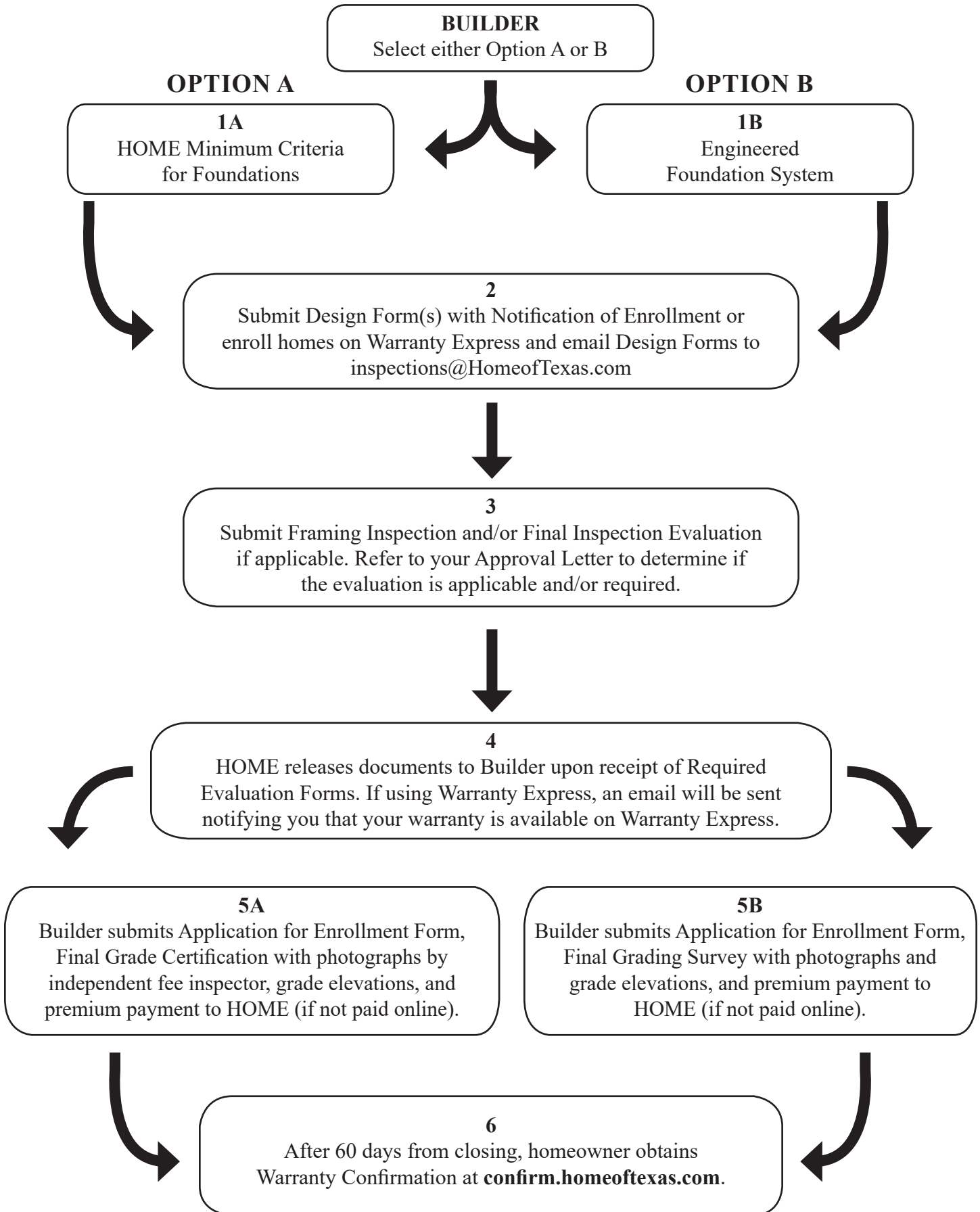

Manufactured and Modular Addendum to The Technical Standards and Guidelines for Builders and Engineers

The guidelines outlined in this Addendum are in addition to the requirements set forth in the Builder Agreement between a member Builder and HOME of Texas (HOME).

Modular homes that fall with the Texas Department of Licensing and Regulation for Industrialized Housing and Buildings shall be designed in accordance with the “HUD Permanent Foundation Guide for Manufactured Housing”. Member shall construct the home in accordance with the Texas Department of Licensing and Regulation for Industrialized Housing and Buildings, Responsibilities of the Industrialized Builder for Site Construction and Inspections. Upon request by HOME of Texas, the Builder shall show the Texas Department of Licensing and Regulation requirements have been complied with including providing HOME of Texas with a copy of the Set Inspection Report Form showing that SET inspections were performed when the modules or modular components were connected and fastened to the foundation.

Areas Designated Catastrophe Areas by the Texas Department of Insurance Standards and Guidelines Addendum

The following counties are described as Texas’ “First Tier Counties” and designated catastrophe areas by the Texas Department of Insurance:

Aransas, Brazoria, Calhoun, Cameron, Chambers, Galveston, Jefferson, Kennedy, Kleberg, Matagorda, Nueces, Refugio, San Patricio, Willacy and certain cities east of State Highway 146 in Harris County: La Porte, Morgan's Point, Pasadena, Seabrook, Shoreacres.

For homes built in the listed “First Tier Counties”, Builders must comply with the Texas Department of Insurance (TDI)’s Windstorm Inspection Program. The TDI’s requirements include submitting to the TDI, the TDI’s Application Form (WPI-1), submission of the (WPI-2) document sealed by an engineer confirming the appropriate inspections were performed, and obtaining the Certificate of Compliance (WPI-8) to certify the property meets windstorm building code requirements.

Following the procedures below will satisfy HOME of Texas’ technical requirements as otherwise described in this booklet and will be accepted in lieu of the design certification and the final grade certification documentation:

- In order to have the Application For Enrollment Form available to you for closing, for each home located in the Texas “First Tiers Counties”, provide a copy of the WPI-2 engineer’s certification of inspections document and/or provide a copy of the WPI-8 Certificate of Compliance to HOME of Texas.
- In order to validate coverage for each home located in the Texas “First Tiers Counties”, provide a copy of the WPI-8 Certificate of Compliance and the completed and signed Application For Enrollment form and payment to HOME of Texas.



5300 Derry Street
Harrisburg, PA 17111